

A man with dark, curly hair and a light beard is wearing a light blue blazer over a white t-shirt. He is sitting at a desk, talking on a black smartphone held to his left ear. His right hand is on the keyboard of a silver laptop. The desk is a light wood color. In the background, there is a dark blue, textured wall and a matching blue upholstered chair. The lighting is soft and focused on the man.

MARKANT
health & productivity

Hybrid

Activity Based Working

Hybrid Activity Based Working

In the last few years the way of working has changed immensely. There is a shift of functions in an office, moving more towards Activity Based Working. Tasks are becoming more varied, challenging, mobile and with more deadlines. Collaboration or time spent with colleagues being in different areas and even time zones, is becoming quite common.

Employees need places where they can be undisturbed and able to do individual work or relax. Professionals must have a physical environment that not only supports but also motivates and inspires. Informal working environments within an office stimulate encounters, creativity and the exchange of ideas.

Workplace adaptability is crucial for success and employers who recognise this new and profound reality are a step ahead of the competition in recruiting and retaining high performing talent.

Hybrid brings the comforts of home to the office and creates the best place to work while being seated, standing or in motion. Changing the physical character and social experience of the workplace stimulates flexible workers to spend more time in the office and be more productive and hit targets.

Hybrid reduces the sedentary time that is still deteriorating people's health in the long term. Hybrid stands for Activity Based Working in an informal and healthy manner.



The Hybrid collection can be divided into three categories: Workstations, Soft Seating and Tables. These three furniture categories form the uniform Hybrid collection and share the same design features, like the stunning wooden legs and extensive fabric colour range.

Sit To Stand Workstations

The 12cm thick screen, with height adjustable worktops on each side is lifted from the floor and mounted between the typical Hybrid legs on each end. All technology is hidden inside these screens and cables can be placed in the integrated gutter at the bottom, making it possible to guide the cables from workstation to workstation. The Max Hybrid workstations are available in different lengths and colours and can be connected to create longer benches for four, six or more users. The space efficient Wing bench is also part of the Hybrid Collection.

Modular Soft Seating

Different configurations for various activities can be created utilising the soft seating modules, which blend perfectly with the Hybrid workstations and tables. The high and low seats can be reconfigured or extended to new configurations in the future. Small, integrated table tops for individual use or bigger table tops for meetings in an acoustic booth can all be created according to the requirements of each working space.

Meeting Tables

The table legs are available in both standing and sitting height and table tops can be clustered together to make long benches. Short individual notebook sessions, group meetings, presentations or other activities like having your lunch can be done at a table. These multifunctional tables are a fundamental factor to creating a uniform and complete Hybrid interior.

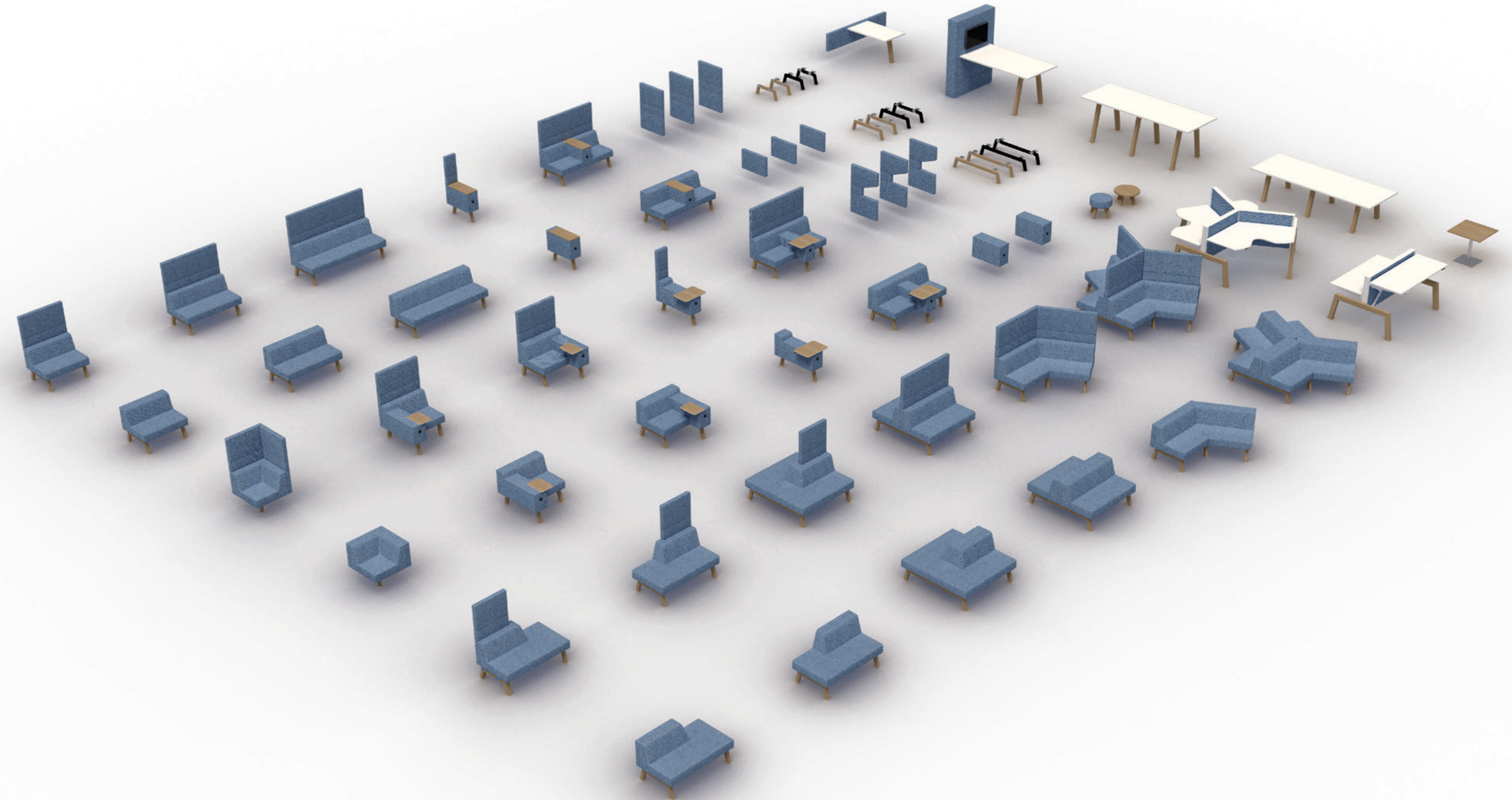





Wing Seaters

The open 120 degree Wing Seater creates the perfect setting for a spontaneous meeting with a colleague or a short individual work session, where people still can be seen, but benefit from the privacy and acoustics of the high backrest.

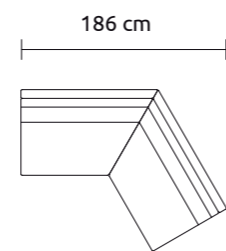

Hybrid Wing Seater

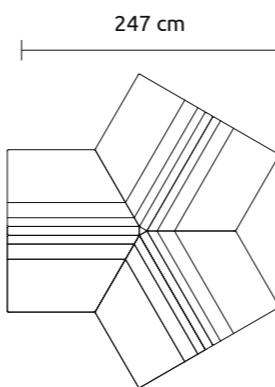

Hybrid Wing Seater Twin



Wing Sit To Stand

The Wing worktop offers users more primary countertop space compared to a rectangle shaped worktop. The use of two monitor screens fits perfectly in the 120 degree shape of the screens between the workstations.

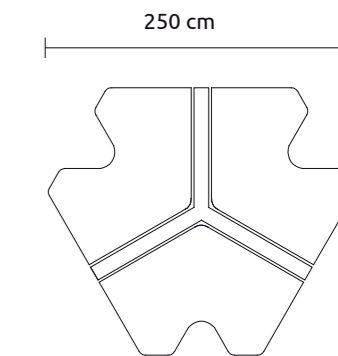

Hybrid MAX Wing 100

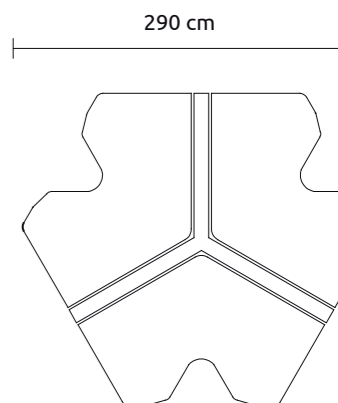

Hybrid MAX Wing 120



Elbow - For guiding the cables from the worktop to the gutter below the screen inside.



Mediaspace - Fully integrated cable gutter at the backside of the worktop with integrated power sockets and monitor arm grommet.



Q4 Monitor arm - To support height and depth adjustable monitor screens for optimal ergonomics. Available for double and single monitor screens.



Ergo Curve - For better support of the arms of the users in sitting and standing position, making the armrest of the task chair redundant.



Removable Screens - With hidden magnets the upholstered panels can be easily removed - making it possible to change the fabric colours in the future.



Upgrade - The Max Hybrid workstations can be upgraded from a comfortable sitting workstation to an dynamic standing desk.



Agile Working

Hybrid excels in agile working where projects are divided into a series of short and clear sub-projects. Project teams work closely together, communicate personally with each other and regularly with other stakeholders.





Personal Productivity

The integrated worktops of Hybrid optimally support Activity Based Working. Sliding and moving the top towards the user creates a comfortable work spot like a business seat on your favourite airline, adaptable to different users. At the front a standard power socket with extra USB port is integrated to connect to the network.

Spontaneous Collaboration

By moving the swivel tops to the front and rotating 180 degrees, the table top can change into a small meeting table, ideally positioned when you like to share your laptop screen with the person next to you.

Private Communication

The high upholstered backrest simultaneously absorbs and blocks the sound of a phone call or conversations with a colleague. At the same time these people benefit from being separated from the disturbing noise of the surroundings.



Personal Productivity

Spontaneous Collaboration

Private Communication



Hybrid Meeting POD

By placing two high couches across each other a semi enclosed acoustic work area can be created for flexible working in an open office environment.

By connecting a high screen at the back between these couches with a table attached, the configuration can be upgraded to a perfect meeting POD. Optional power sockets can be integrated in the table with HDMI ports to connect laptops, creating the opportunity for people to share their screens with others on the LCD screen in the middle. Video conferencing becomes more common and this integrated LCD-screens will be the new standard in the near future.





Tables

Although a 'paperless office' is becoming the new standard, working, relaxing or gathering around a table is still indispensable in a working environment. Fixed workstations for each employee might be something from the past, whereas multifunctional tables shared with others and mixed between the soft seating and workstations are becoming more popular. Another example that the office is becoming much more like a living room.

People tend to sit shorter at a high tables compared to the traditional seated tables. Using the worktop of a standing table while standing up is not only practical and comfortable, it also reduces sedentary time while people are working in the office. By placing high tables between the other furniture, people will be stimulated to walk around more, improving their productivity and interaction with others.







Wing Seater (2x)

In a 90 degree corner seat people cannot sit properly on such a tight angle. Angles created with the 120 degree Wing-Seaters offer a better solution and create a playful and more interesting shape.



End-seater (2x)

The end-seater with the extended seating part without backrest becomes an interesting connection module when two End-seaters are connected together in mirrored position.



Flex Worktop Single (2x)

Rotating work-tops at one or both sides can be integrated at any position of the configuration, next or between two seats, with optional power sockets at the front.



Stool (4x)

Mobility of the people and more flexibility of the facilities can be stimulated by adding these small stools to the lounge configurations.

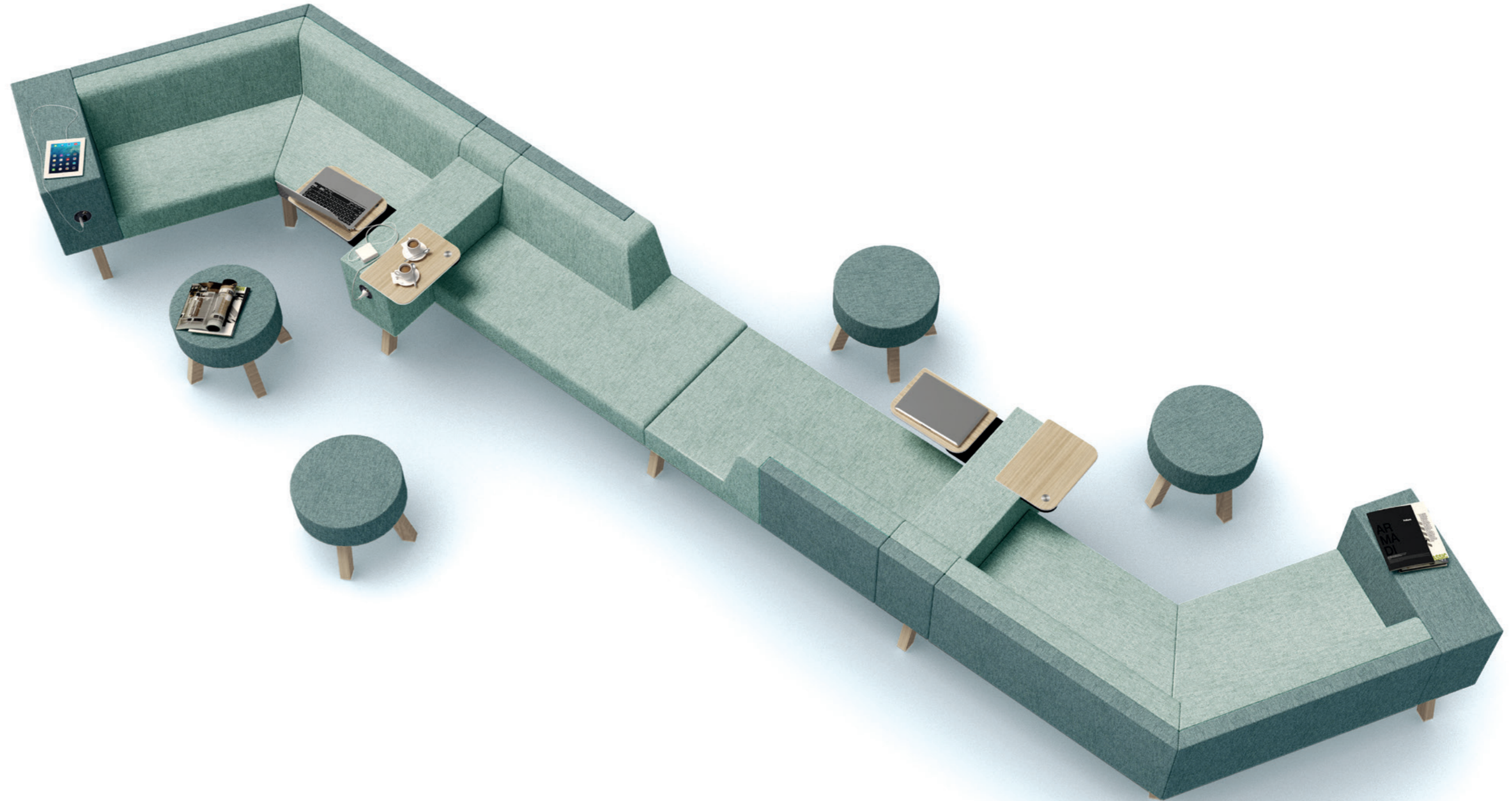





Collaboration

Furniture that supports collaboration and interaction between people increases the output of the most valuable assets of a company: their employees!



Sit and Stand Working

Office workers should regularly work standing up for or walk two minutes every half hour to reduce chances of developing chronic diseases.



Screen Sharing

Integration of communication hardware connects people over long distances (video conferencing), reduces the use of paper in the office (working in the cloud) and improves communication (screen sharing).



Modularity

Creating playful landscapes that can adapt to the requirements of each space, supporting diverse activities that can be reconfigured in the future for new possibilities.



Uniformity

Sharing the same design characteristics and natural materials (like the wooden legs) creates a 'pleasant' interior with less formality that feels like a living room.



Flexibility

'Business class' worktops that can slide to or from the body and can rotate so that people always have a pleasant working posture.



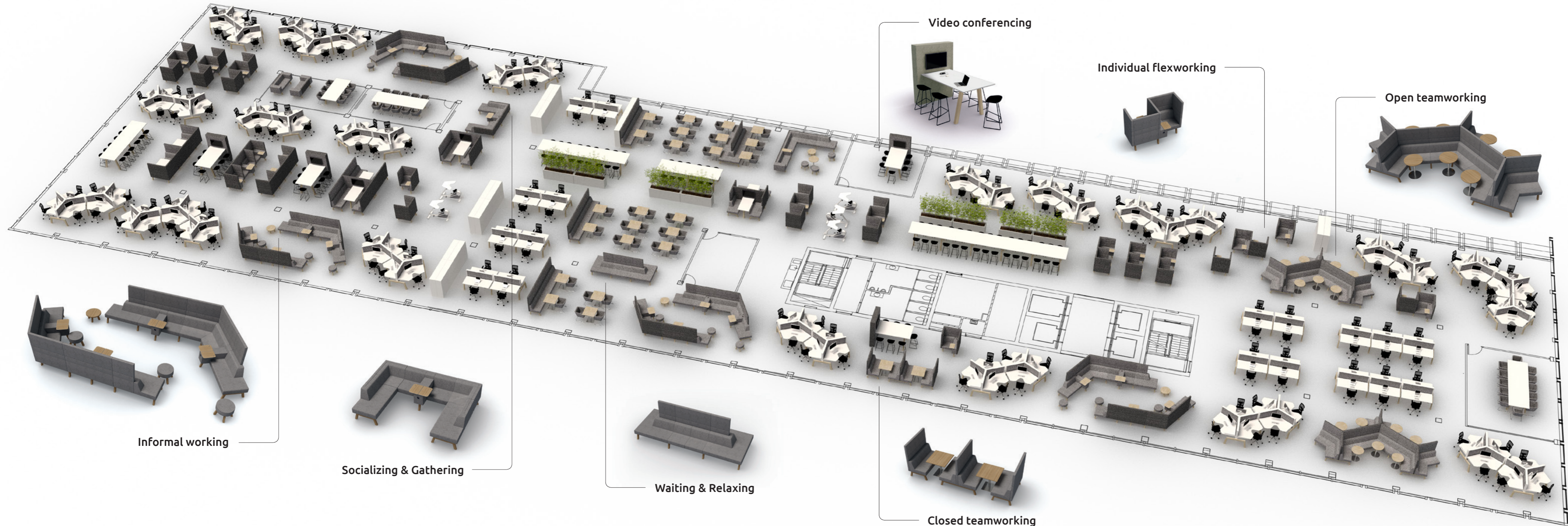

Video conferencing

Individual flexworking

Open teamworking

Informal working

Socializing & Gathering

Waiting & Relaxing

Closed teamworking



Office like a Living Room

Today people are connected to their private and business network at the same time, shifting their activities and focus constantly, while they are using multiple devices at the same time.

If workspaces resemble living rooms when your work-life and social life are integrating, then furniture should take on a less formal look. Laptop working on a couch or at a table is almost identical: the new standard for both is that power sockets to plug in your mobile device have become a basic necessity in commercial, public and private interiors.



Separation

When the high backrests of the Hybrid seating modules are connected, a separated zone can be created inside an open interior, offering privacy and acoustics inside. Ideal for Food & Beverage places in offices, but also often used for 'student places' in the educational sector or waiting areas at airports or other public buildings.



Corner Seater (2x)



3-Seater (2x)



3-Seater (2x)



Column-Table extended (4x)



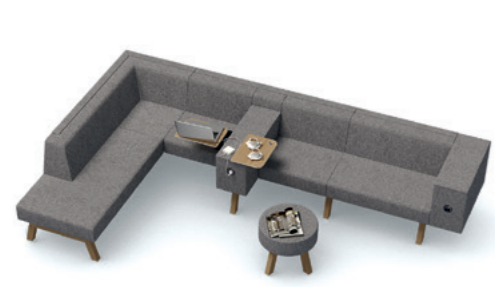

101



102



103



104



105



106

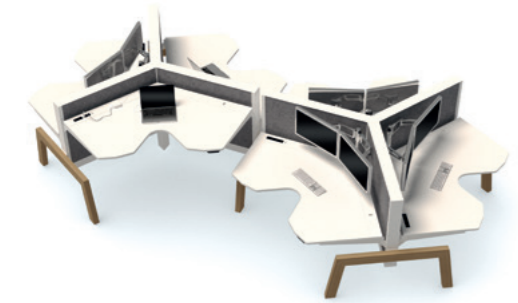

107

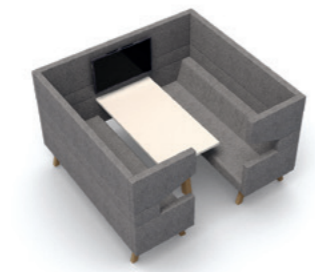

108



109



110



111



112



113



114



115



116



117

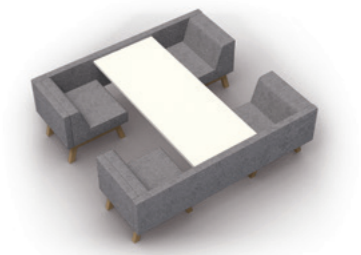

118

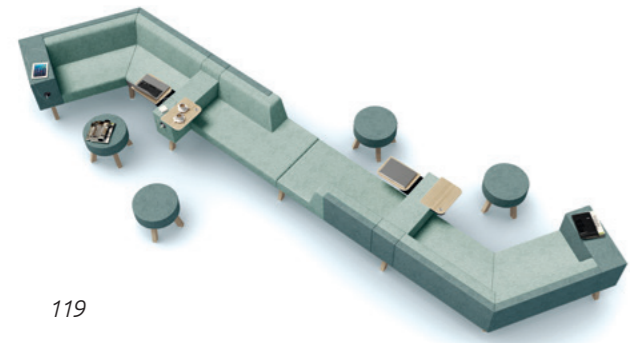

119



120



121



122

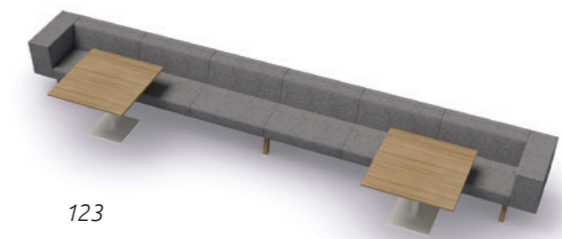

123



124



corner seater high



single seater high



2-seater high



3-seater high



left seater high

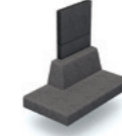

right seater high



twin end seater high

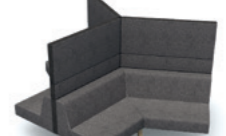

twin wing seater high



corner seater low



single seater low



2-seater low

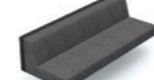

3-seater low



left seater low



right seater low

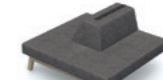

twin end seater low



twin wing seater low



flex worktop double high



flexstand double high



flex worktop right high



flex worktop left high



flex worktop single high



flexstand single high



twin seater high



wing seater high

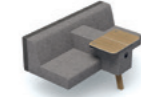

flex worktop double low



flexstand double low

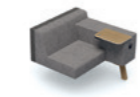

flex worktop right low



flex worktop left low



flex worktop single low



flexstand single low



twin seater low



wing seater low



option side-screens and armrests



different legs



stool

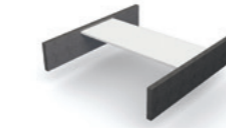

screen-table for POD-4 corner



screenshare table



screen-table for POD-2

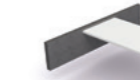

screen-table for POD-4

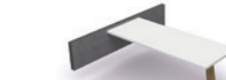

Screen-table for POD-6

Fabric - Rhapsody

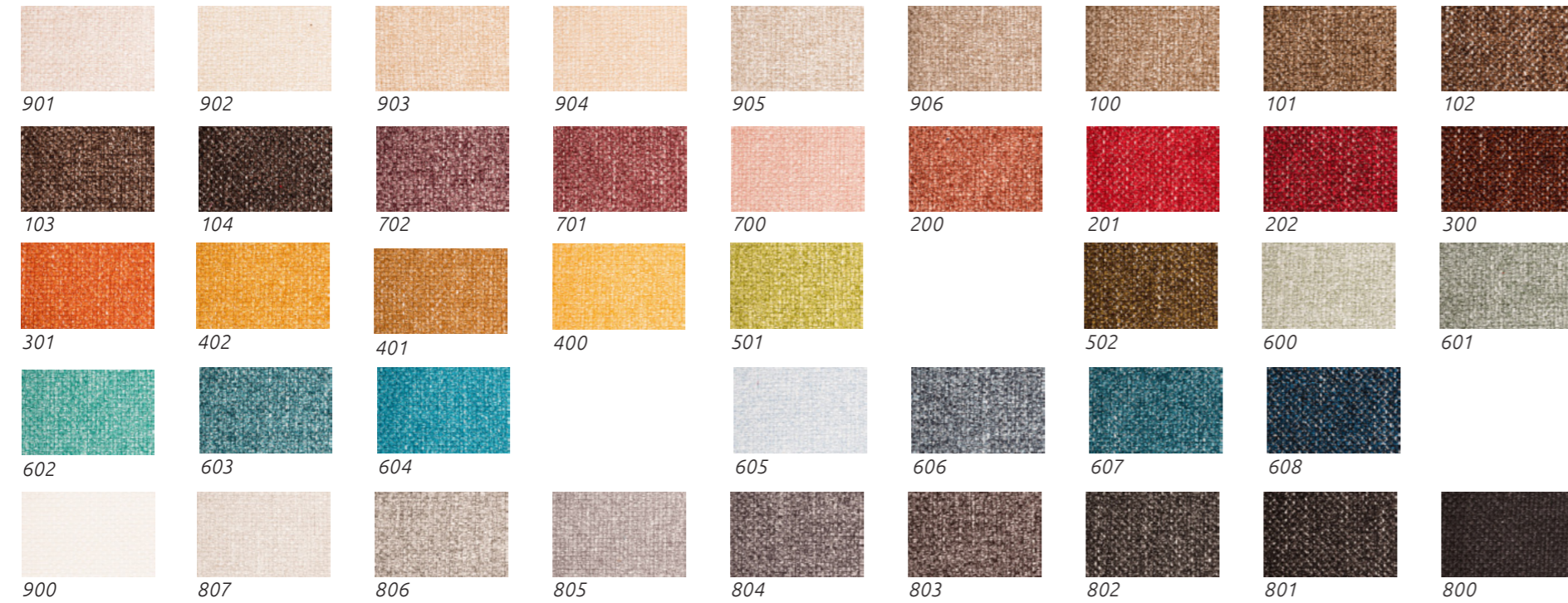

Fabric - Harmony

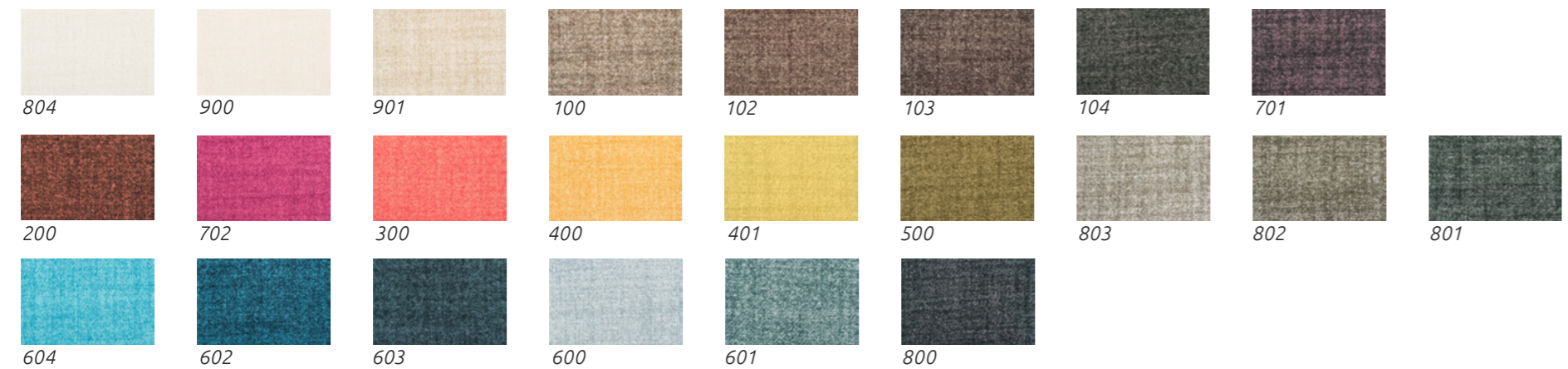

Table & Sofa Legs

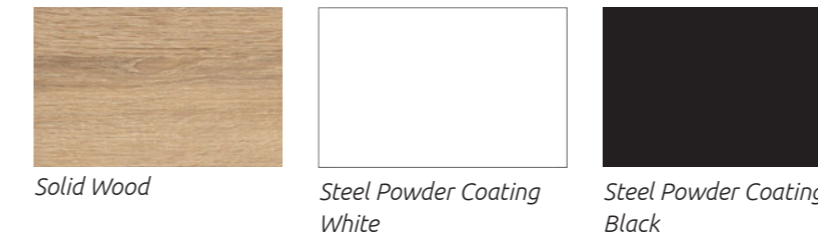

Table Worktops



Flex Worktops



MARKANT

health & productivity

Markant Netherlands

Elzenkade 1, 3992 AD Houten

The Netherlands

T: +31 30 693 69 69

E: info@markantoffice.com

Markant Australia

C/O 15th Landing - Level 1/175 Collins Street

Melbourne, VIC 3000, Australia

T: +61 03 8102 9030

E: australia@markantoffice.com

Markant Office Furniture Sdn. Bhd.

Lot 523, Batu 13 1/2 Jalan Klang Banting

42600 Jenjarom Selangor, Malaysia

T: +60 3 3191 7246

E: malaysia@markantoffice.com

markantoffice.com



BS-EN 527-1
& BS-EN 527-2